

# CAPTCHA



什么是CAPTCHA

- CAPTCHA

**C**ompletely  
**A**utomated  
**P**ublic  
**T**urning test to tell  
**C**omputers and  
**H**umans  
**A**part

<http://www.captcha.net/>

<http://en.wikipedia.org/wiki/CAPTCHA>

The image shows a registration form with the following fields:

- Name:** First and Last name input boxes.
- Choose your username:** A single input box with a placeholder "@gmail.com".
- Create a password:** A single input box.
- Confirm your password:** A single input box.
- Birthday:** Month (dropdown), Day, and Year input boxes.
- Gender:** A dropdown menu with "I am..." as the selected option.
- Mobile phone:** A country code dropdown (showing "+86") and a phone number input box.
- Other email address:** A single input box.

A blue box highlights the CAPTCHA challenge at the bottom of the form:

- Prove you're not a robot:** The instruction text.
- Image:** A distorted image containing the text "rebuild:".
- Type the two pieces of text:** The instruction for the user to type the text from the image.
- Input:** A text input box for the user's response.
- Buttons:** Refresh, back, and help icons.

- A program that generates and grades tests that are human solvable but beyond the capabilities of current computer programs
- 全自动区分计算机和人类的图灵测试
- 验证码，一种区分用户是计算机和人的公共全自动程序

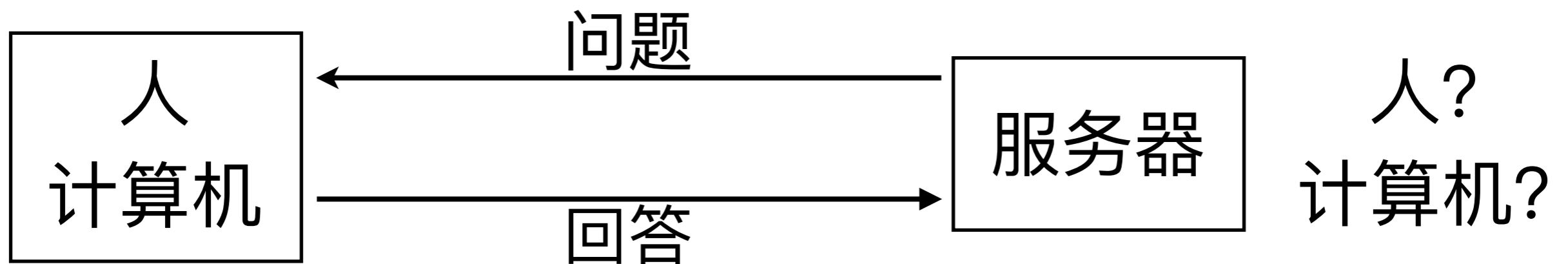

- 1996, Moni Naor
- 1997年, AltaVista
- Yahoo邮件是第一个大规模采用CAPTCHA的网站
- 2000年, von Ahn和Blum设计出第一个抵御OCR的CAPTCHA
- 2007年, reCAPTCHA
- 2007年, NoCAPTCHA
- ... ..

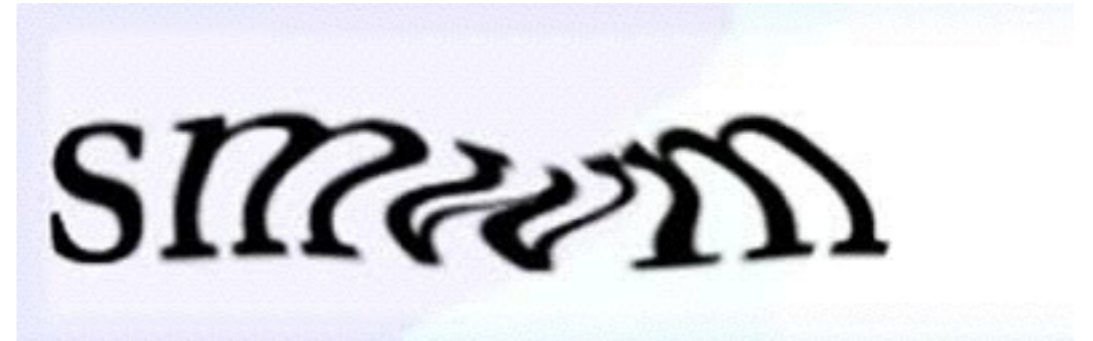

---

HIPs:

Human Interactive Proof

---

OCR:

Optical Character Recognition

- 判断人还是机器

- ✳ 保护网站用户注册，提供免费服务给用户而不是bots

- ✳ 保护搜索引擎，防止评论spam

- ✳ 确保在线调查更可信，防止虚假投票

- ✳ 防止spam制作者很容易的获得email地址

- ✳ 防止针对口令系统的字典攻击

- ✳ 抵御bots

## SPAM

	Registration
	Blogs/Articles
	File Downloads
	Contact Forms
	Online Voting
	Seach

- 设计CAPTCHA

- ✱ Email

- ✱ BBS

- ✱ Blog

- ✱ SNS

- ✱ Security

- ✱ ... ..

AI难题

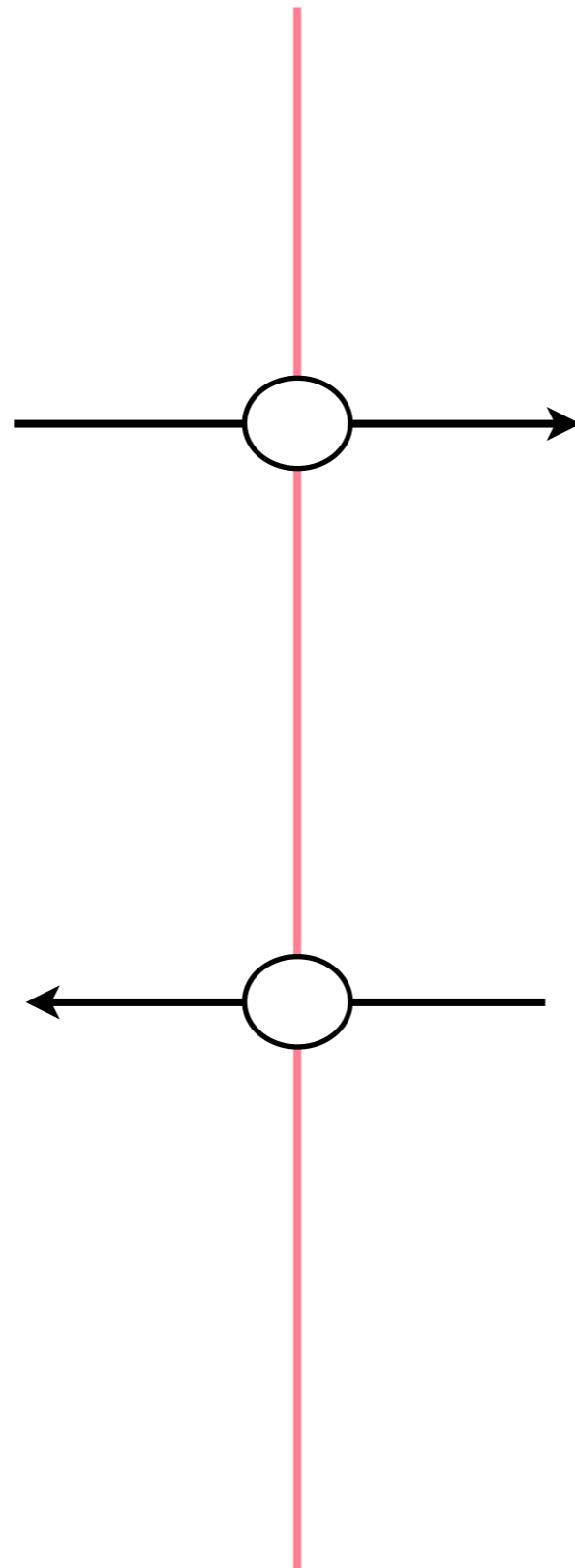

- 攻击CAPTCHA

- ✱ 垃圾信息生产者

- ✱ 僵尸网络掌握者

- ✱ 打码等其余攻击者

- ✱ 自动化测试人员

- ✱ ... ..

机器学习

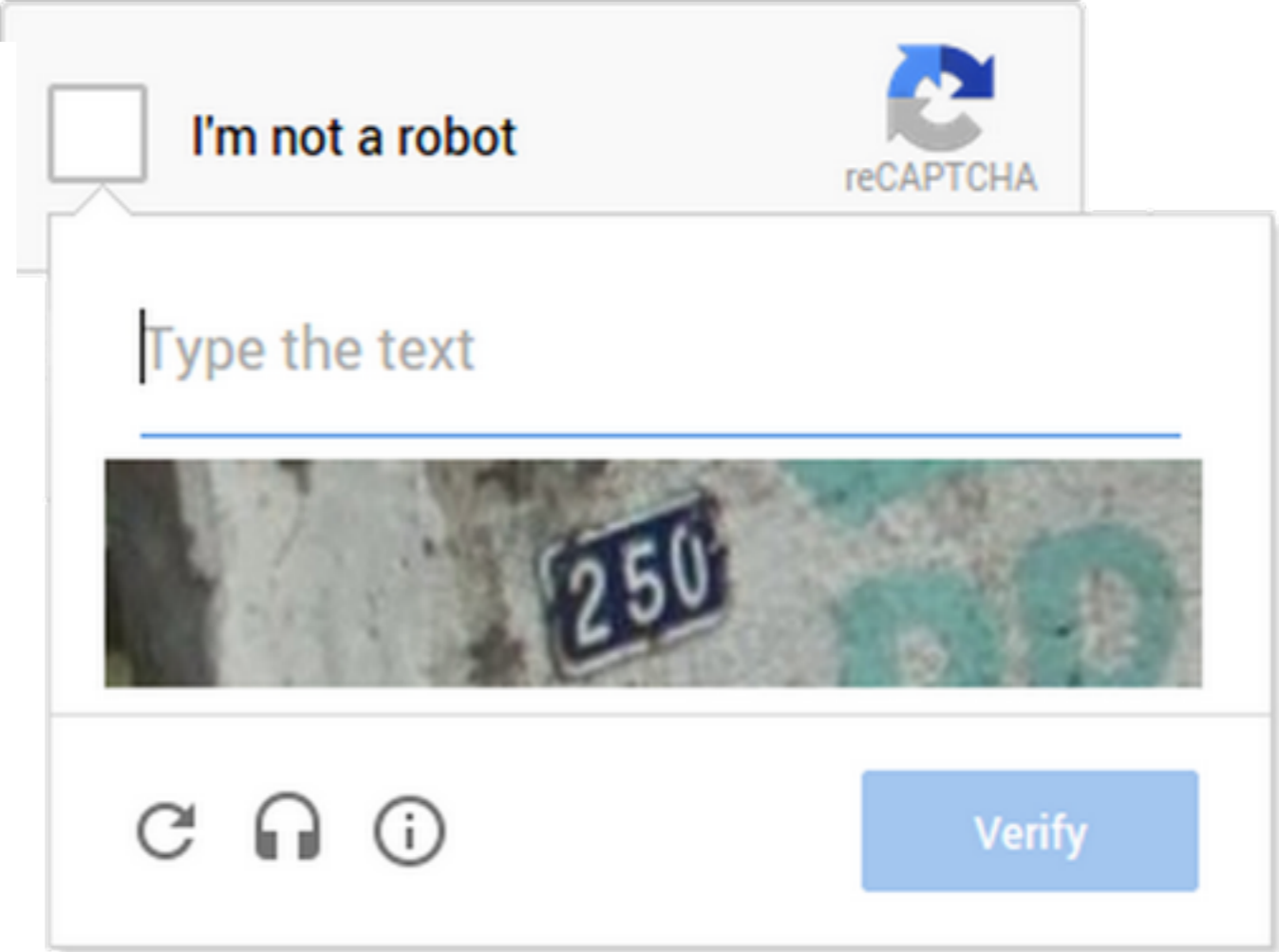
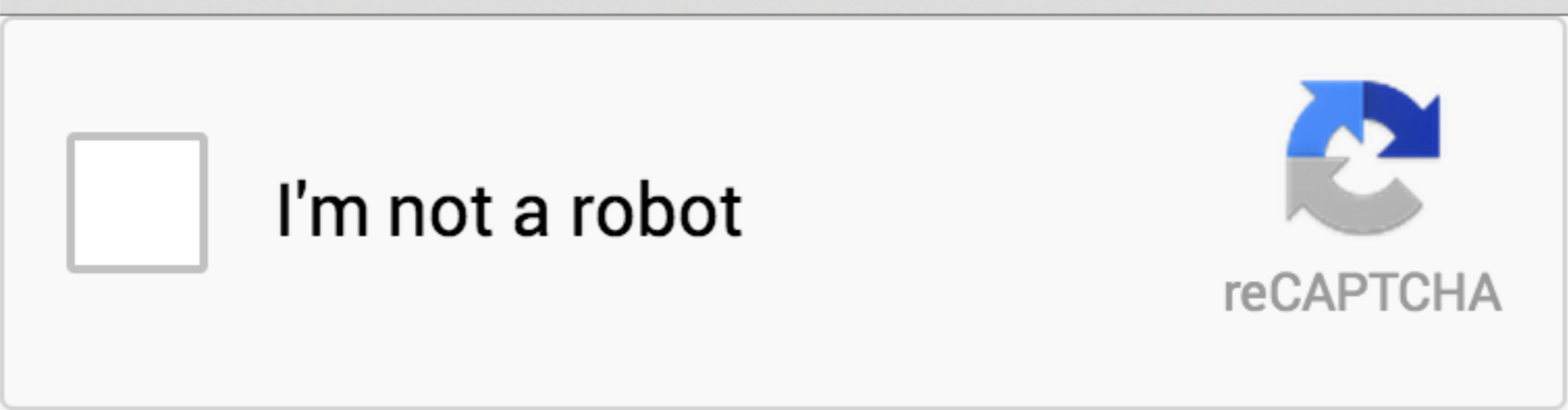



文本CAPTCHA

- 请进入如下图片的文字

sunhp@ss.pku.edu.cn

- 文字如下:

sunhp@ss.pku.edu.cn

- 
- 像素点
  - 图片：二维的像素点
  - 计算机不能识别图片中包括什么文本
  - 计算机能识别图片中哪些像素相同不相同

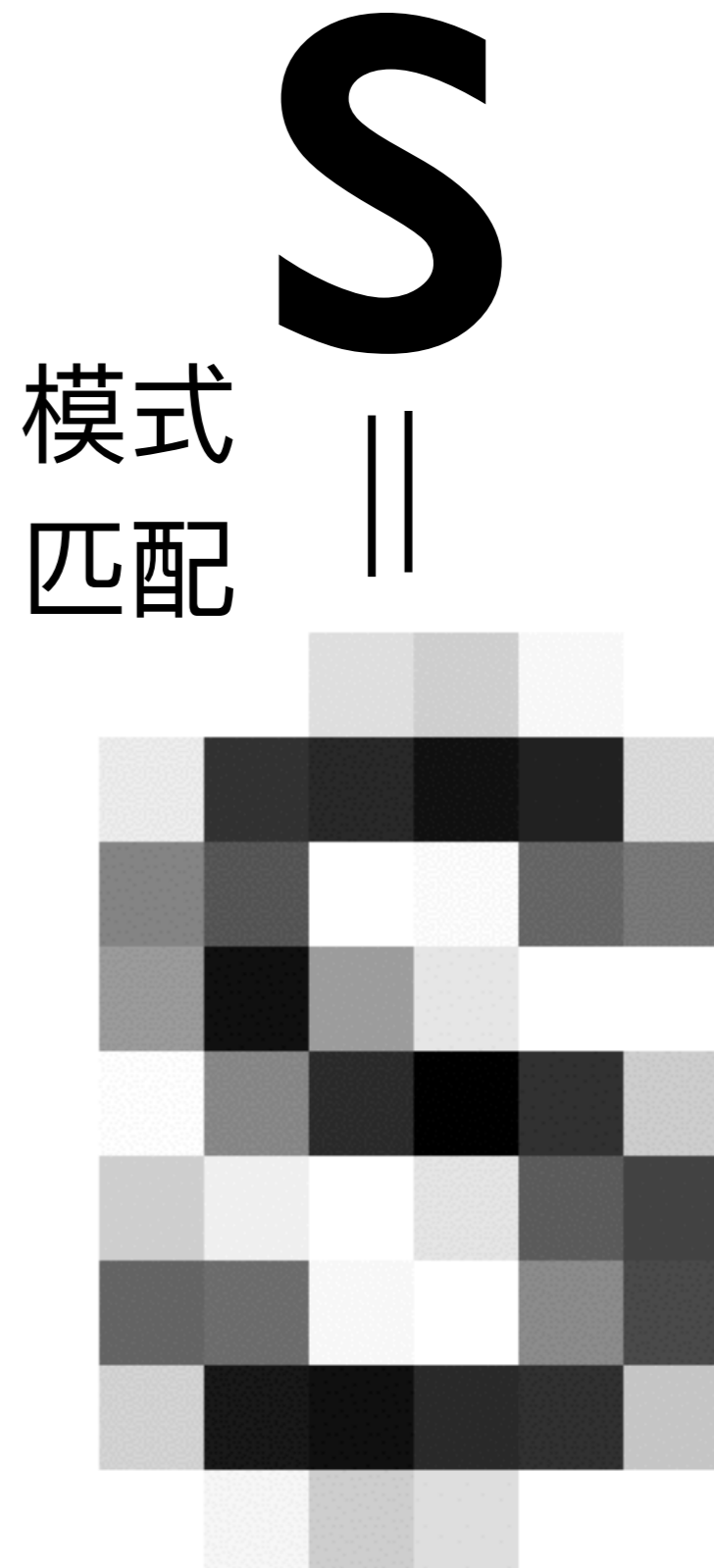

# GIMPY / EZ-GIMPY

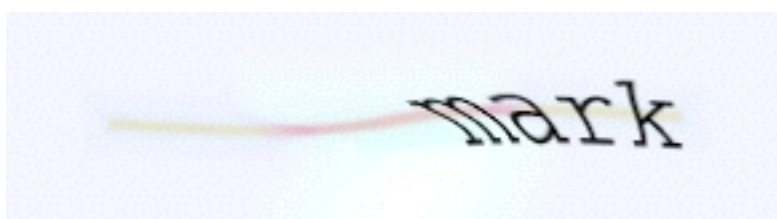
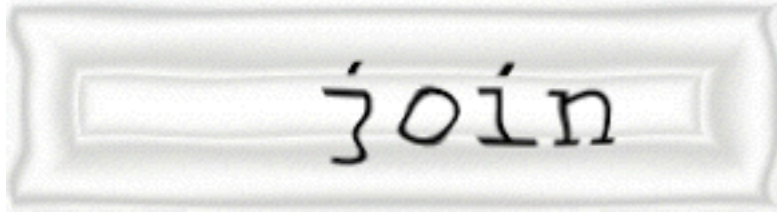
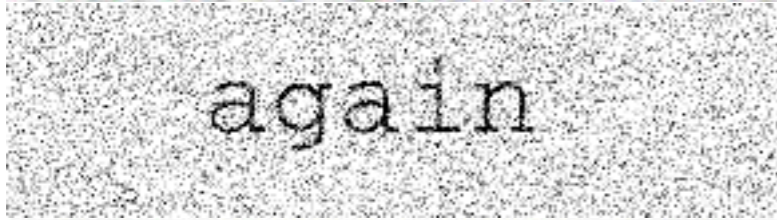
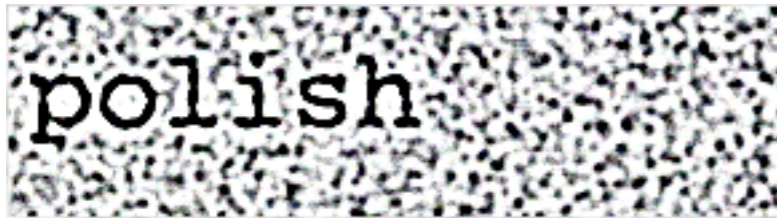

## EZ-GIMPY

Enter the word as it is shown in the box below.

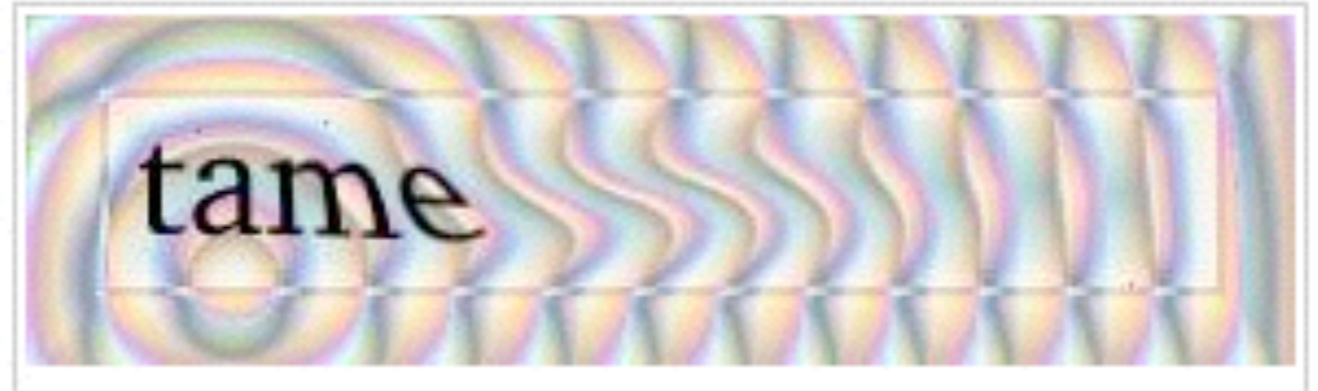

## GIMPY

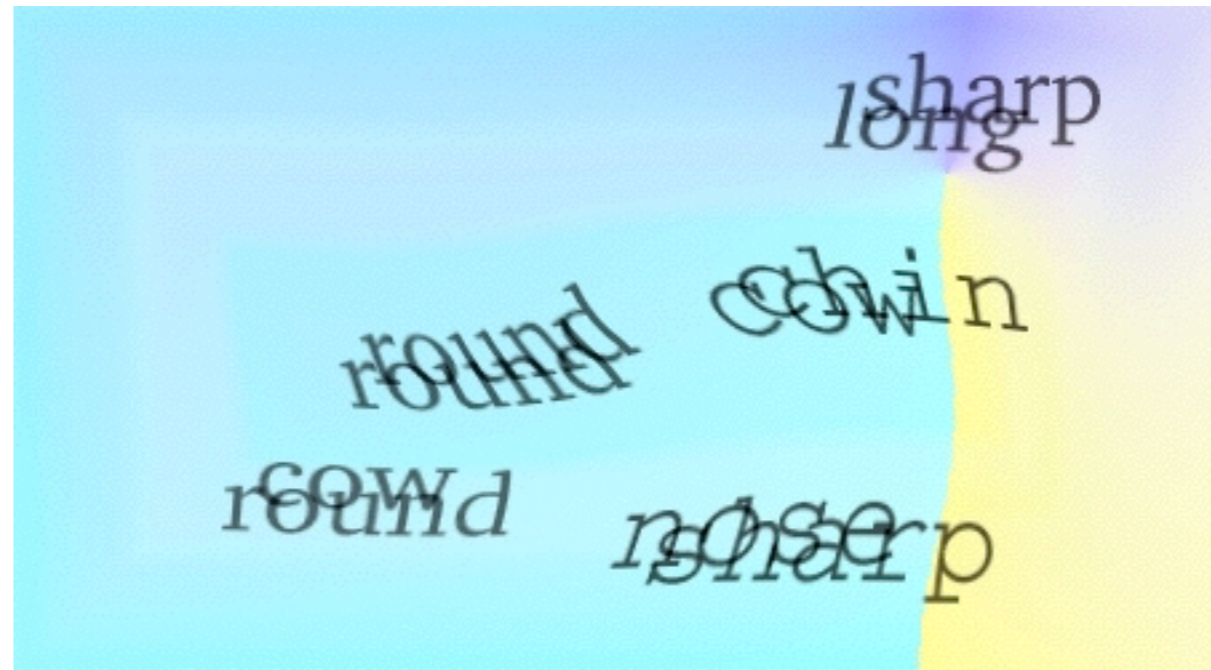

Yahoo's EZ-Gimpy



假设：人能读  
扭曲的文本，  
但计算机不能

一般情况下要求  
用户输入扭曲图  
像中的文字

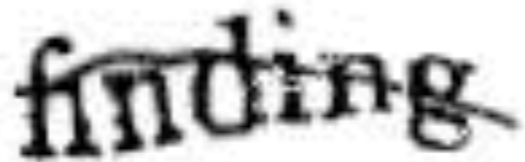
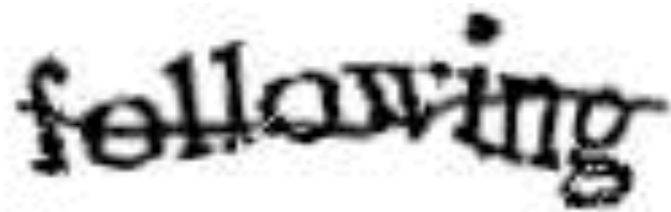

增加一条曲线使得  
图像分割更困难

将符号彼此拥挤在一起，但是人也比较难于识别

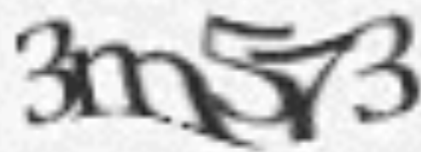

# 常见文本CAPTCHA



谷歌的验证码



QQ的验证码



新浪的验证码

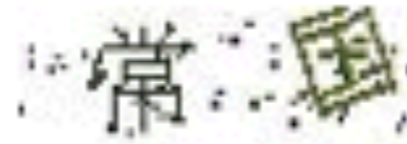

网易的验证码



人人网的验证码

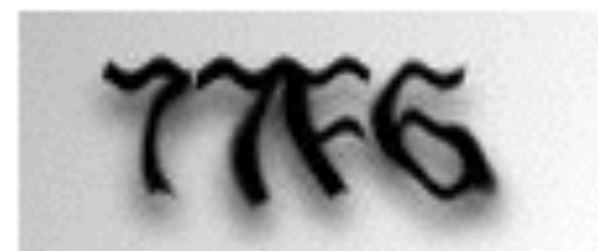

天涯的验证码

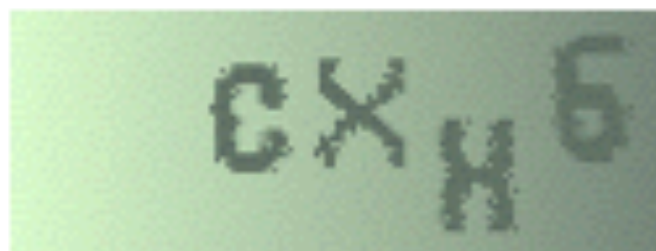

Discuz的验证码



北大软微论坛

# Text CAPTCHA

# 人为攻击CAPTCHA

任务名称	每码价格	更新周期	结算状态	赚友推荐	操作
银河答题 (超简单)	28👉	1天	05月07日金币已发	👍165	继续任务
阳光打码 (日赚30)	15👉	1天	05月07日金币已发	👍1435	立即参与
打码兔 (日赚50元)	17👉	1天	05月07日金币已发	👍2625	继续任务
知码打码 (强力推荐) <b>活动</b>	24👉	1天	05月07日金币已发	👍3311	立即参与
点图打码 (夜班力荐)	28👉	1天	05月07日金币已发	👍26	立即参与
图像打码 (积分结算)	15👉	1天	05月07日金币已发	👍371	立即参与
极速打码 (工号加前缀)	16👉	1天	05月07日金币已发	👍476	立即参与
超速打码 (奖励超高) <b>活动</b>	16👉	1天	05月07日金币已发	👍1036	立即参与
发财打码 (积分结算)	14👉	1天	05月07日金币已发	👍237	立即参与
大众打码 (积分结算)	10👉	1天	05月07日金币已发	👍399	立即参与



**Bypass  
CAPTCHA**

5k CAPTCHAs  
10k CAPTCHAs  
25k CAPTCHAs  
50k CAPTCHAs  
100k CAPTCHAs

Only US\$6.95  
Only US\$13.90  
Only US\$34.75  
Only US\$69.50  
Only US\$139.00

- OCR: Optical Character Recognition, 光学字符识别

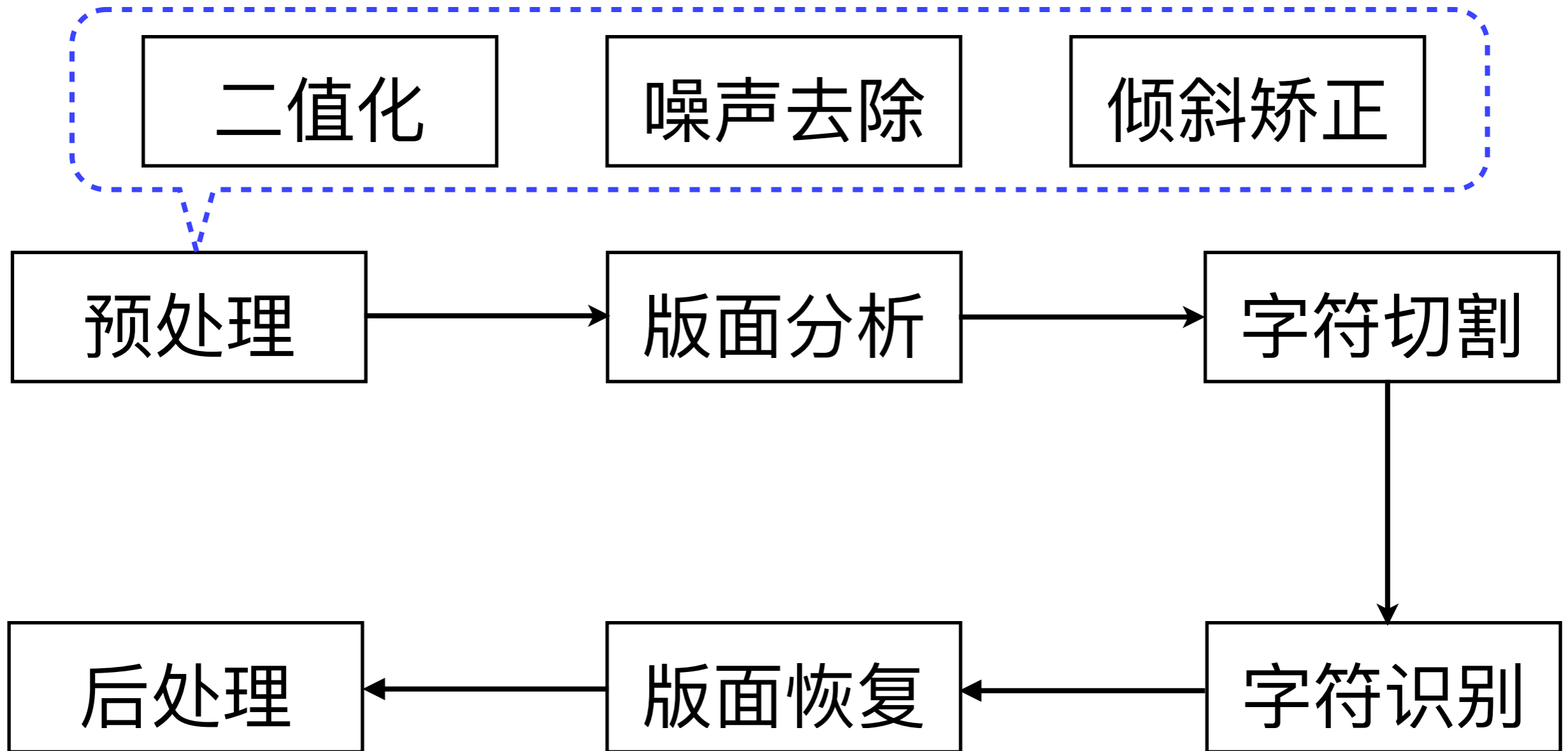



当当

字符分离



京东

字符简单粘连



字符特征粘连

- 像素点个数
- 长宽比
- 像素点密度
- 像素点重心

攻击门限 *0.0.1% or 1%*

挑战空间



# 攻击例子

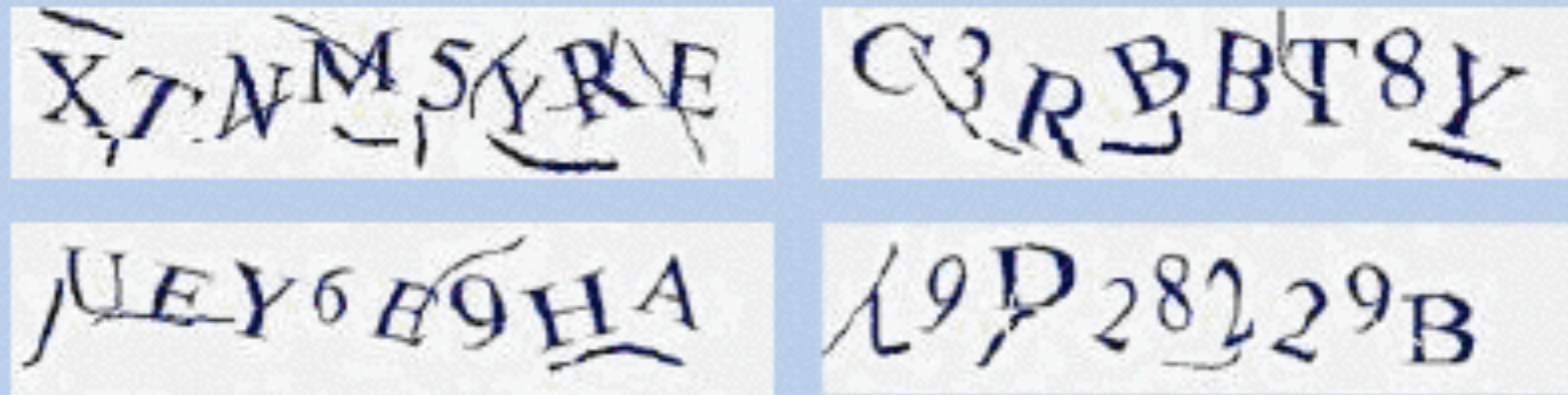

(a)

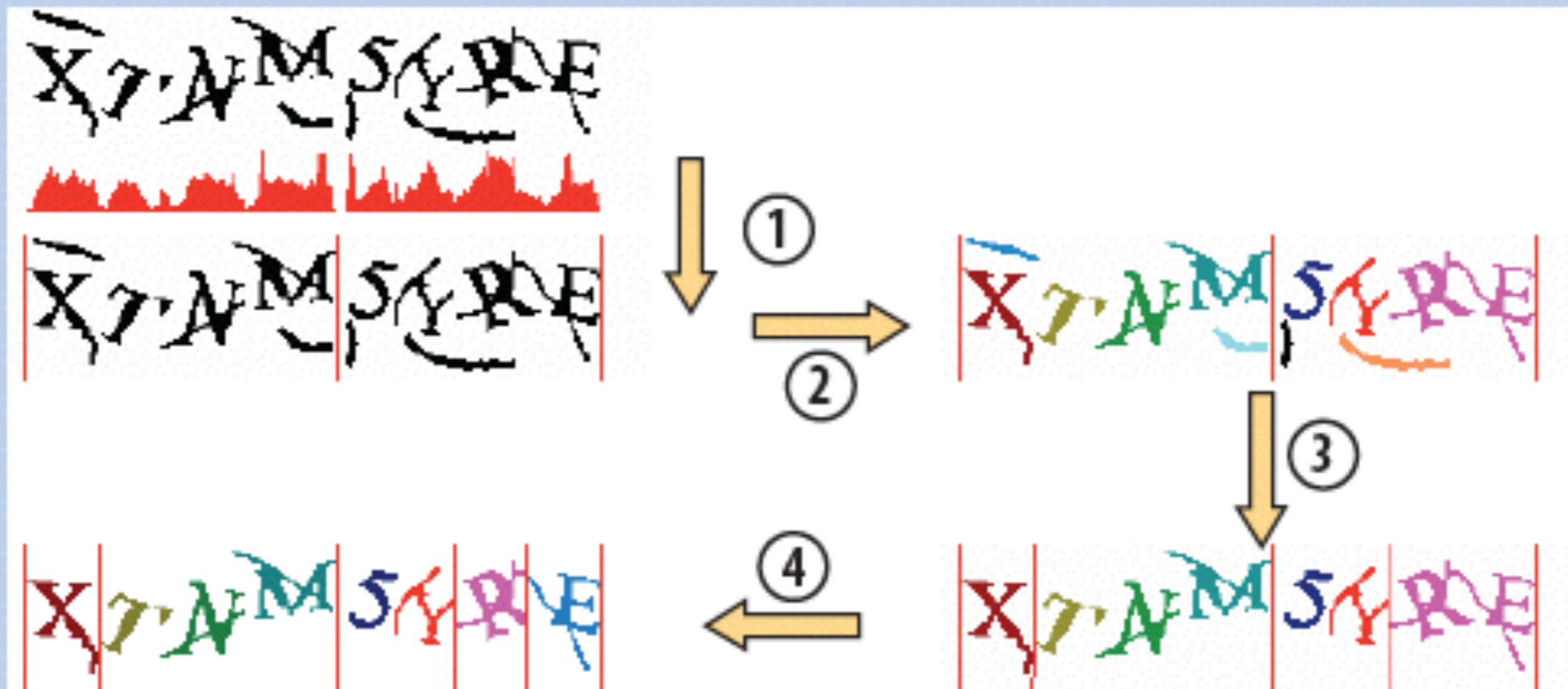

字符：长度、大小、语言、集合、颜色、背景、干扰、扭曲、...

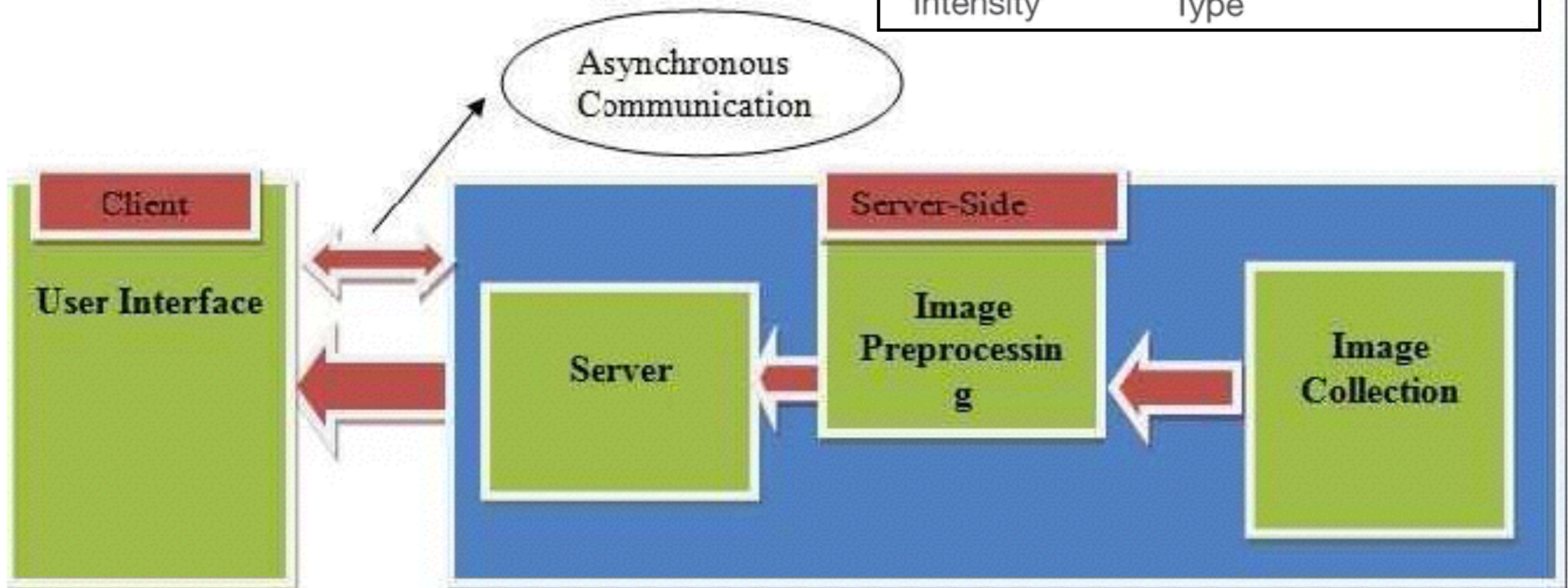
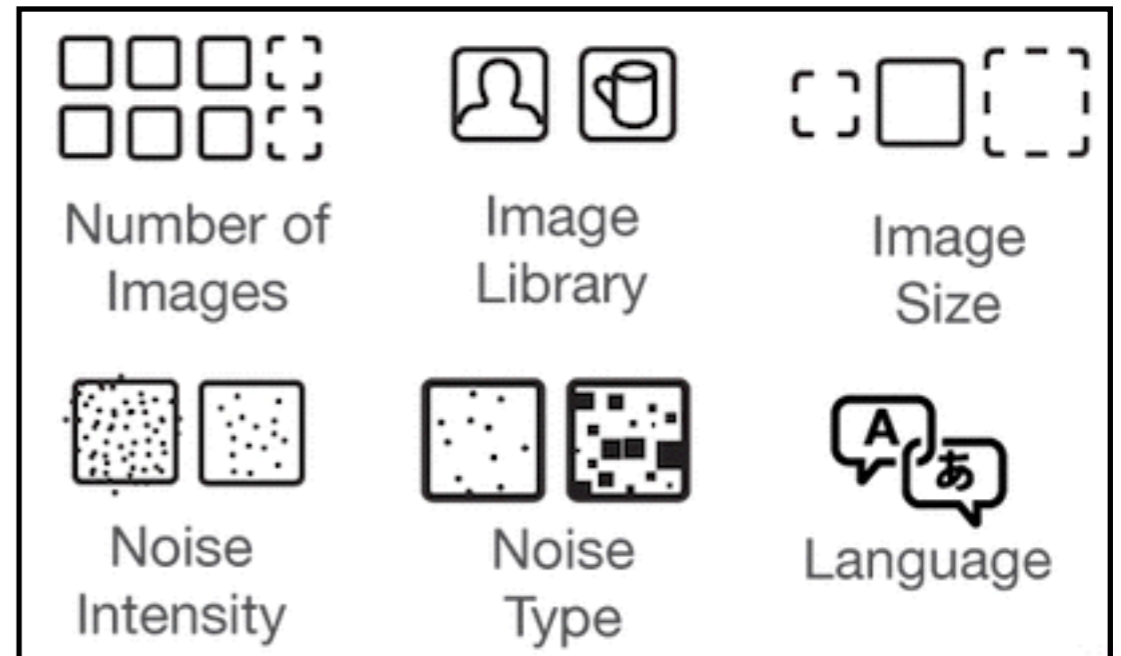

# 常用技术



a. 百度使用的验证码

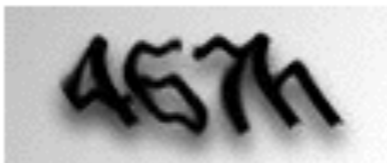
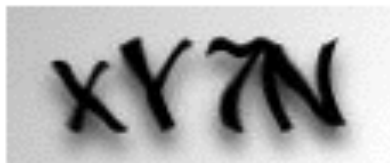

b. 天涯论坛使用的验证码



a. 开心网使用的验证码



b. 谷歌使用的验证码

粘连

扭曲

干扰线

其余



a. QQ使用的验证码



b. 新浪网使用的验证码

- 不定字符
- 不定字体和大小
- 背景干扰

AUD, IR, MIOR

# 声音CAPTCHA

overlooks      inquiry

Type the two words:

reCAPTCHA™  
stop spam.  
read books.

# 分类CAPTCHA

Please click on all the images that show cats:











Score Test

You're a human!

# 分类CAPTCHA

Select ALL the images containing one or more **buildings**

[Powered by Picatcha](#) Refresh

Submit

# Other CAPTCHA

# 逻辑CAPTCHA





# 拼图CAPTCHA



基于拼图



[Buy this watch Now!](#)

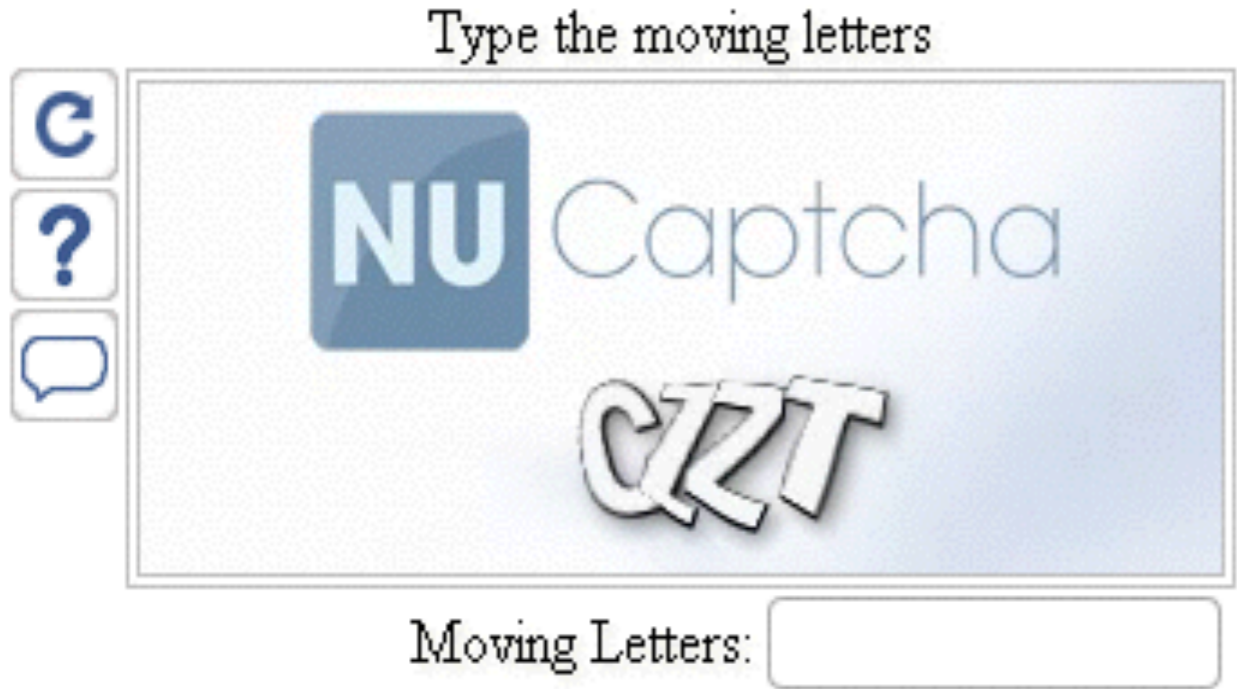

Figure 1: Sample screenshot non animated security settings for NuCAPTCHA

## 用户行为分析系统



Other  
CAPTCHA

CAPY

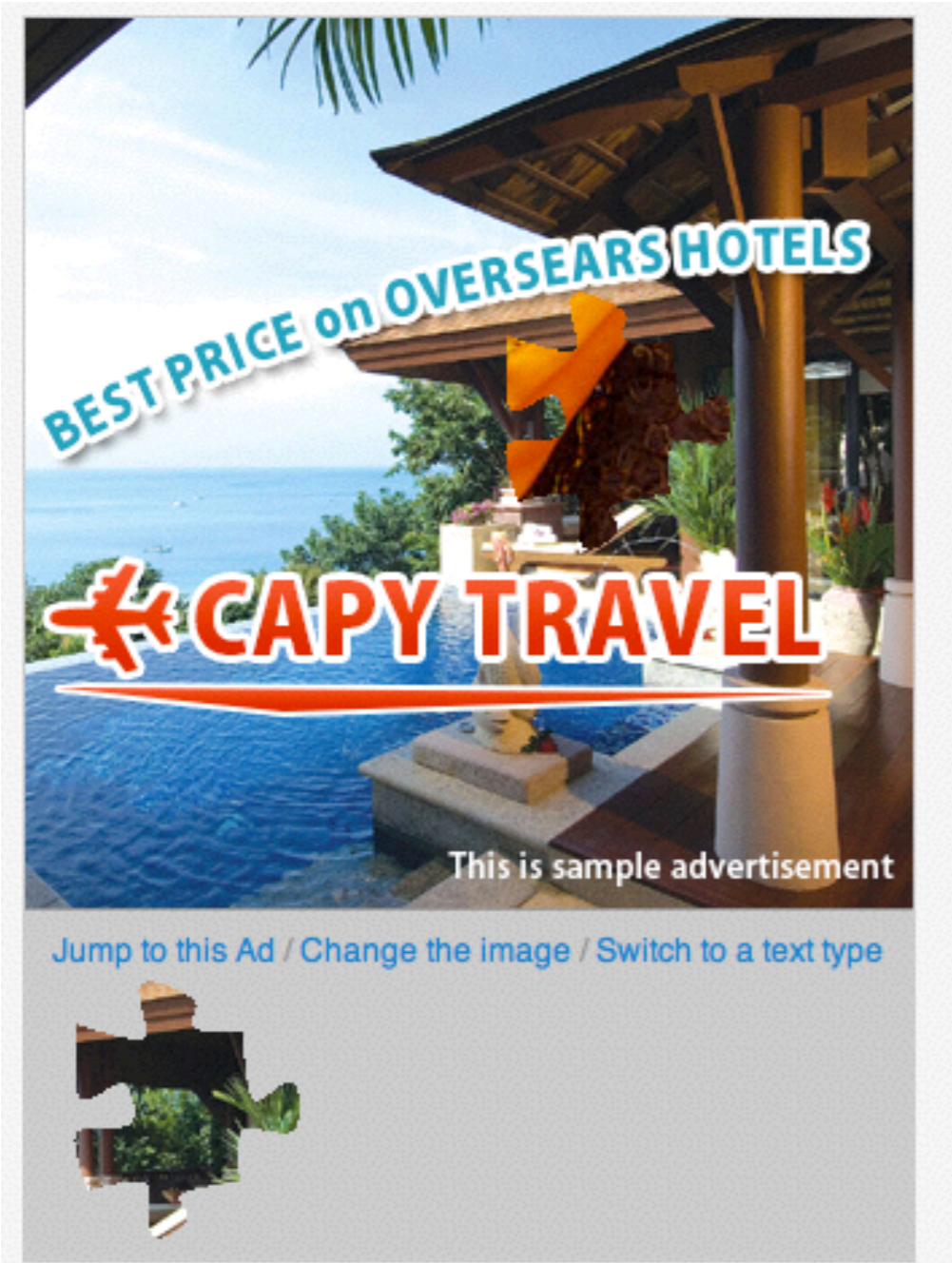

Send

Confirm

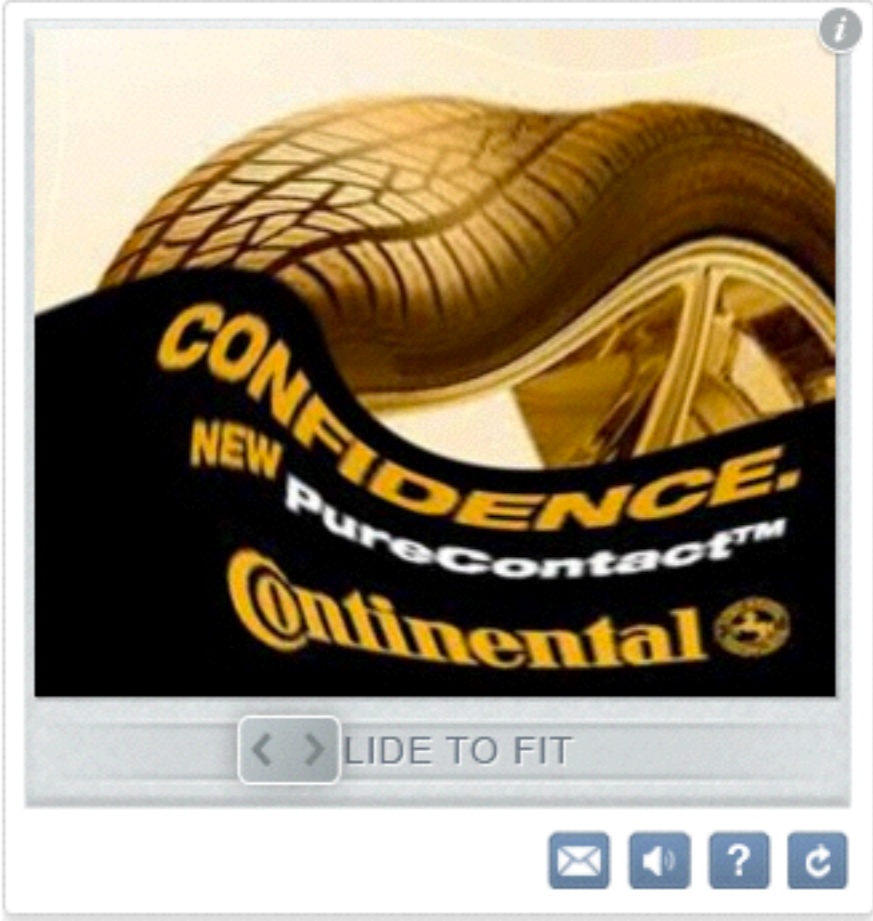

Submit

CAPTCHA

广告

# NLPCAPTCHA



Live life with  
**LUV**  
Life Utility Vehicle



What is Full form of **LUV** ?

 **NLPCaptcha**

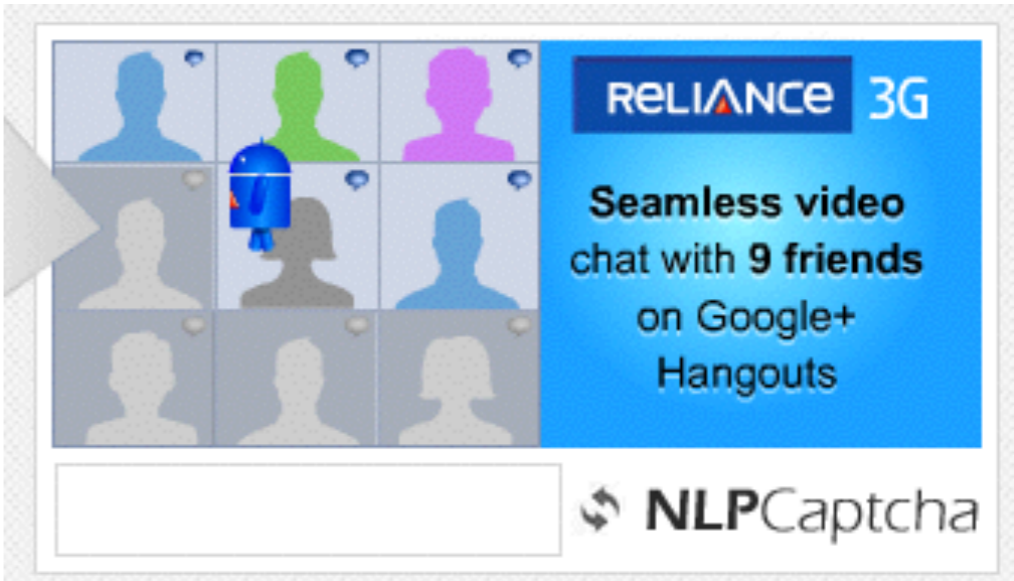

**RELIANCE 3G**

Seamless video chat with **9 friends** on Google+ Hangouts

 **NLPCaptcha**

## NLPCaptcha

Digital Engagement Solutions

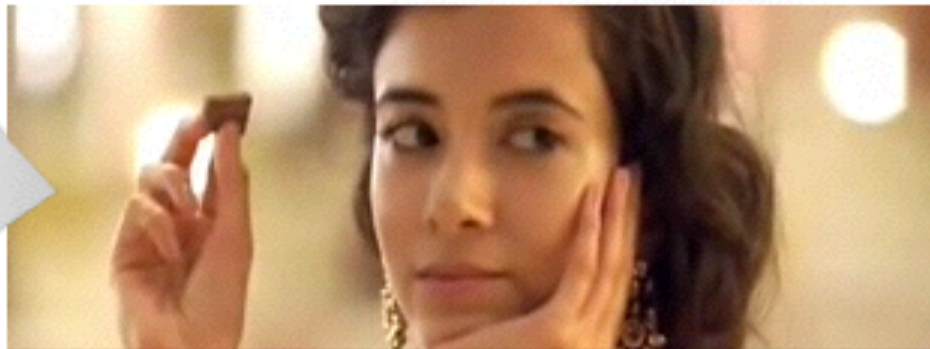
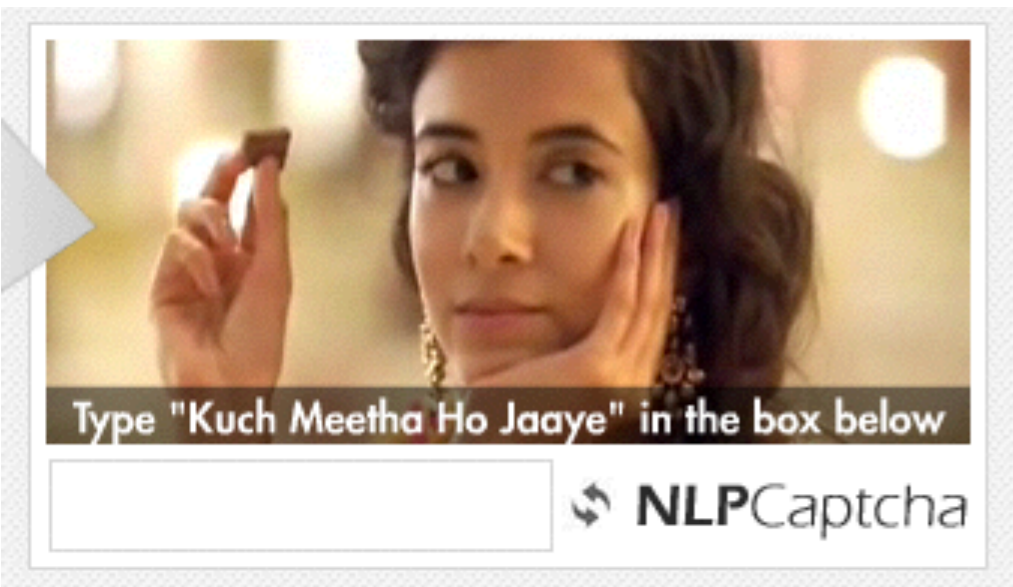

Type "Kuch Meetha Ho Jaaye" in the box below

 **NLPCaptcha**



Describe the above Brand in your worlds

 **NLPCaptcha**



Type the word(s) above

By clicking on 'Create my account now' below, you confirm that you accept the Terms of Service.

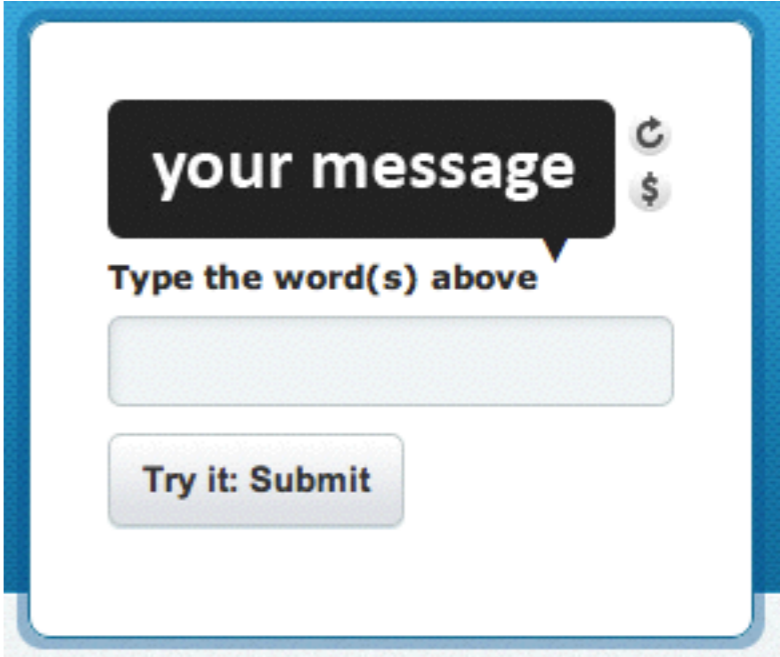

# Other CAPTCHA



# SolveMedia

Please verify your vote by answering the question below and then pressing the "Submit My Vote" button. Close



Please enter: **The all-new Chevy Sonic** 

Your Answer

**SOLVE**media   

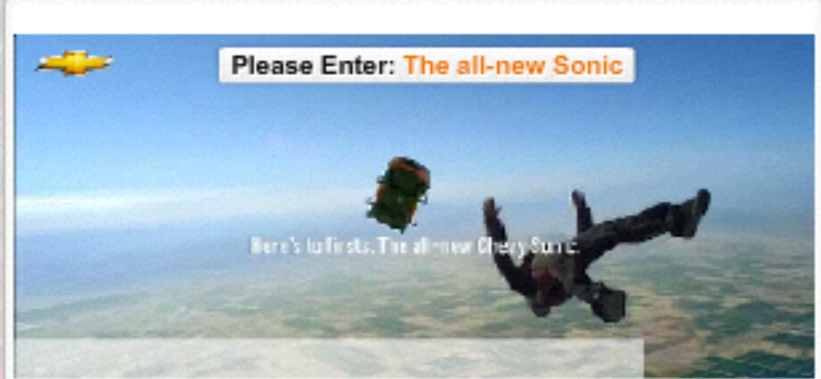

**Submit My Vote**

Please verify your vote by answering the question below and then pressing the "Submit My Vote" button. Close



Please Enter: **The all-new Sonic**

Your Answer

**SOLVE**media   

**Submit My Vote**



Please Enter: **The all-new Sonic**

To skip ad, type in here  **SKIP** **SOLVE**media

480p



describe this brand  
with any word(s)

Your Answer:

**SOLVE**media   



# DoubleRecall



The visitor of a website reads  
your message.

To access the content, type-in the highlighted words.



**Apple iPod** @apple

Movies, TV shows, games, and music. **Now**  
**playing** on an **iPod** near you.

Now playing iPod |

Get content

DOUBLERECALL

[What's this?](#)

A graphic with a possibility  
to link to your site.

To access the content he must type-in  
the words **highlighted** in green.

<http://doublerecall.com/>

## yo! CAPTCHA

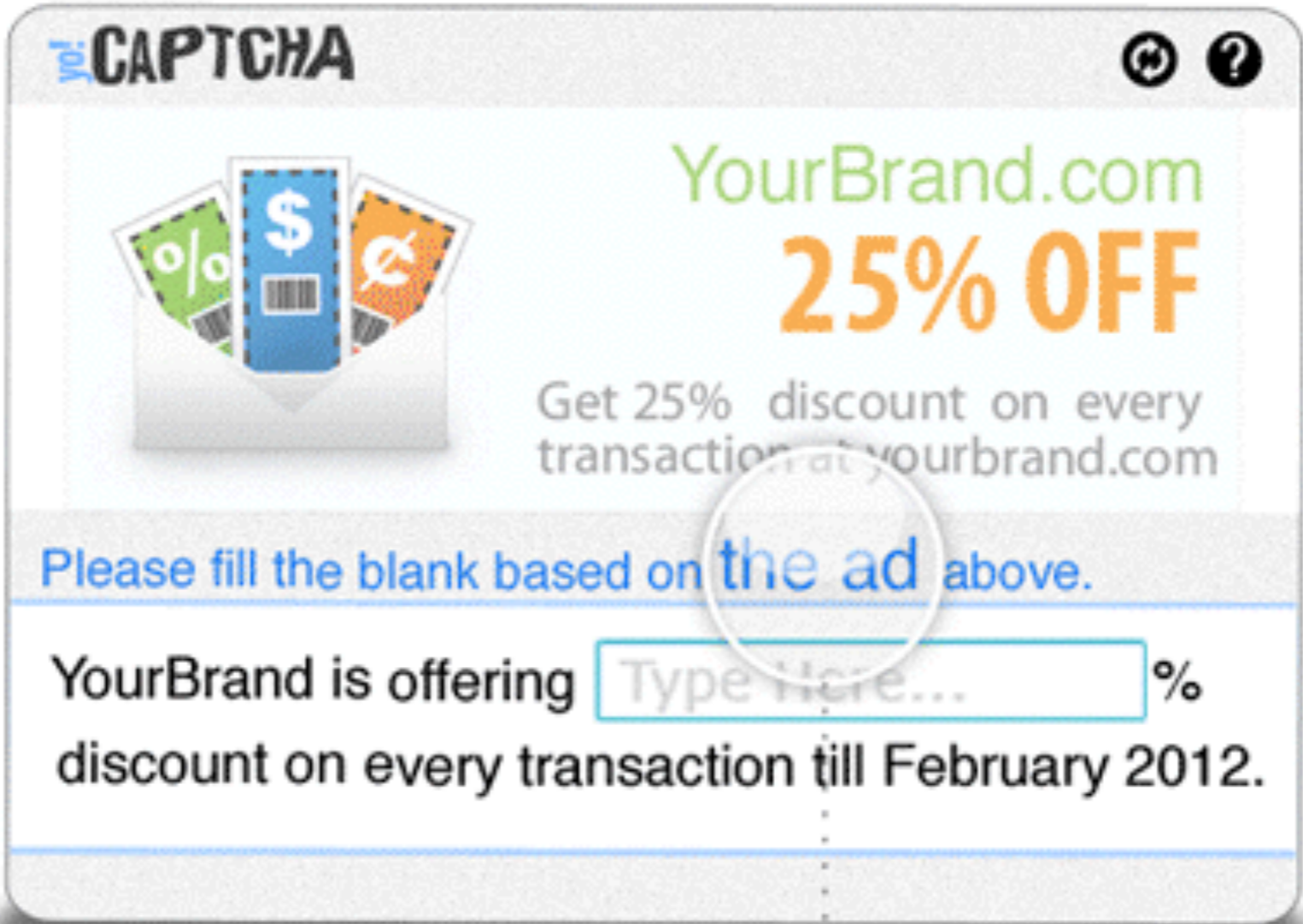

The image shows a Yo! CAPTCHA interface. At the top left is the 'yo! CAPTCHA' logo. On the right are refresh and help icons. The main content area displays an advertisement for 'YourBrand.com' with a '25% OFF' discount. The ad includes an image of three tickets (percentage, dollar, and euro symbols) and text stating 'Get 25% discount on every transaction at yourbrand.com'. Below the ad, a blue instruction line reads 'Please fill the blank based on the ad above.' The main input area contains the text 'YourBrand is offering' followed by a text box with the placeholder 'Type Here...' and a '%' symbol, and then 'discount on every transaction till February 2012.' A vertical dashed line is positioned below the input field.

请输入验证码

**NALA** | 化妆品商城 中国最大的化妆品购物网站!  
www.nala.com.cn

可货到付款 30天退货 100%正品

购物 **0** 风险

请输入图中的**红色**的数字 [点击查看](#)

换一张

印象码

提交

下一站是什么 **XME**

请输入视频中**红色**的字母:

印象码

提交

请输入验证码

平安助您获取  
**无抵押贷款**  
最快一天到账

请输入上图中 **黑色** 的文字 [在线申请](#)

印象码

提交

**印象码**  
YinXiangMa.com 中国第一家验证码广告云服务平台



SONY make.believe

Xperia™ MT27i  
摩炫新势力

参与活动

约**15**mm  
浮空触屏技术

请输入图中**红色**数字



SONY make.believe

Xperia™ MT27i

参与活动 >>

时尚 **NFC** 智触卡

SONY MT27i与你一起智触未来!

请输入图中**蓝色**字符



回复状态 把握梦想

脉动 CUBE  
梦立方

脉动梦立方震撼来袭

开启**百万**级梦想

百万梦想之旅 抢夺神秘包裹 赢取梦想基金

请输入上图中**橙色**汉字



随时脉动回来

3999

梦想基金等你拿 开启梦想之旅

请输入上图中**橙色**数字

# CAPTCHA 和Smartphones

# Smartphones CAPTCHA

# Noise CAPTCHA

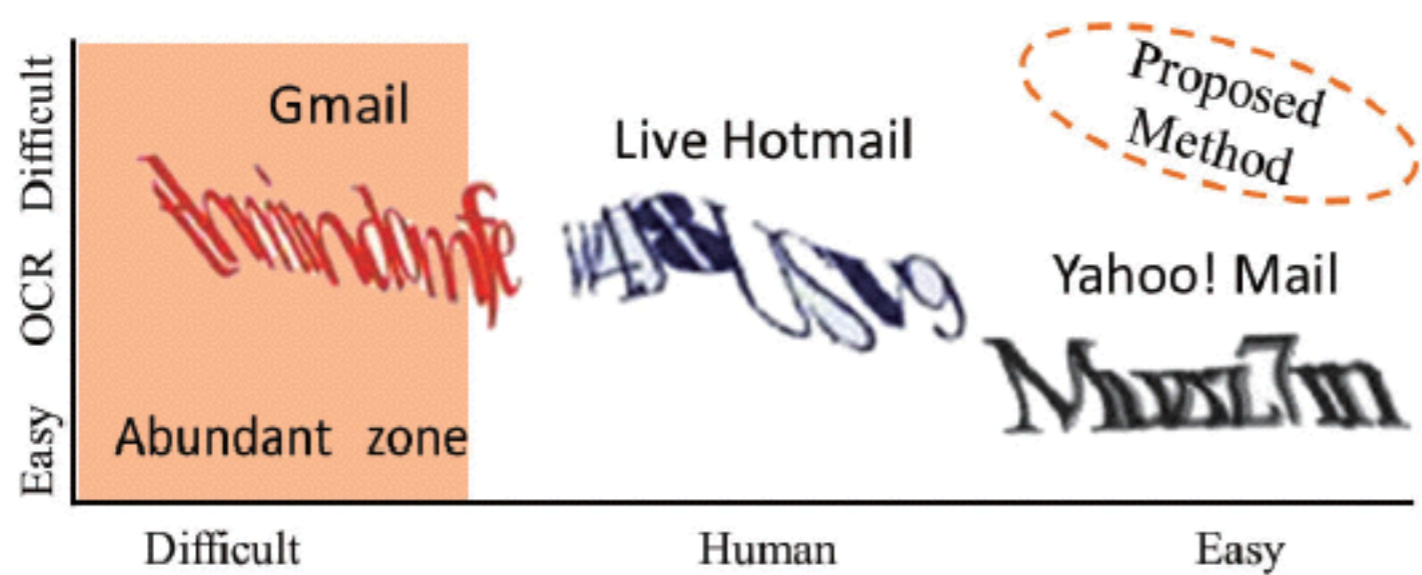

Fig. 2. Gimpy of Google, Live Hotmail, Yahoo mail

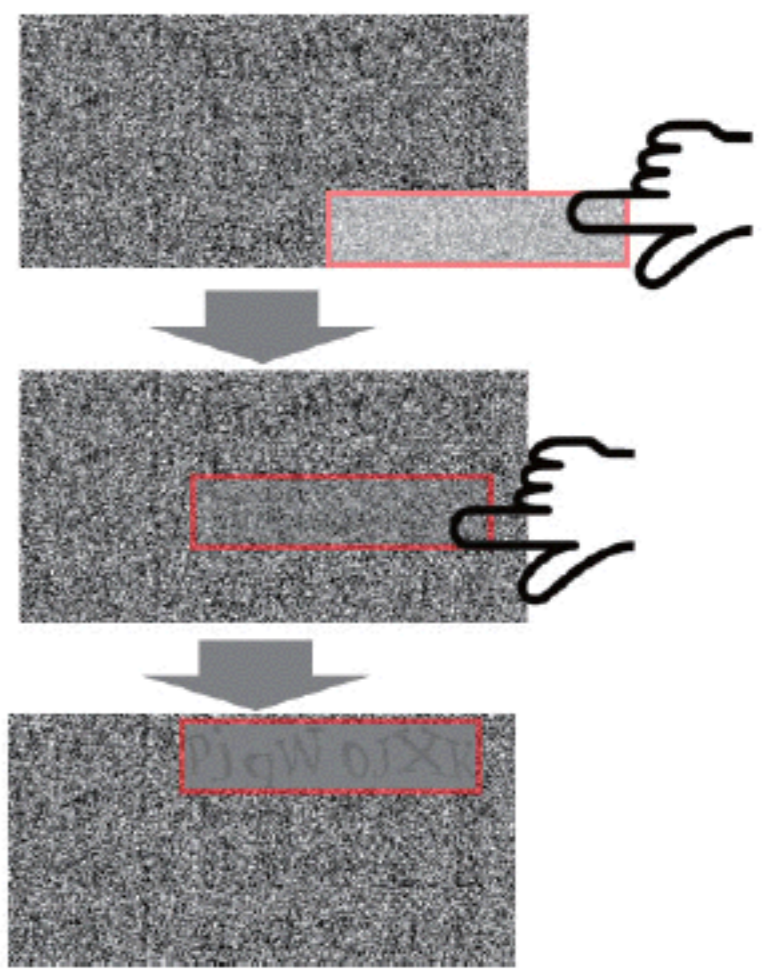
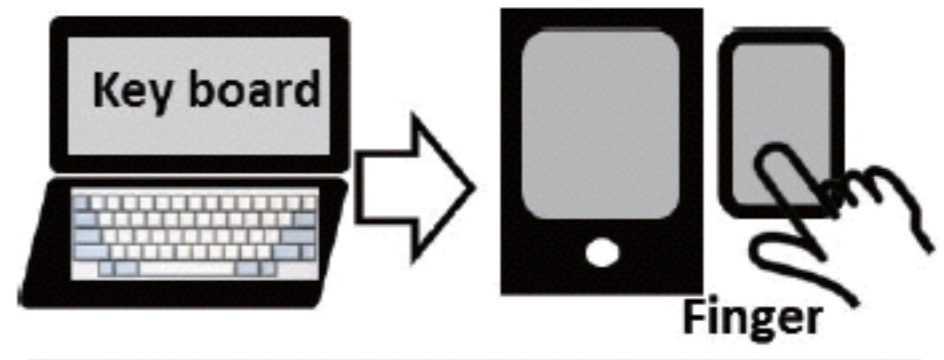
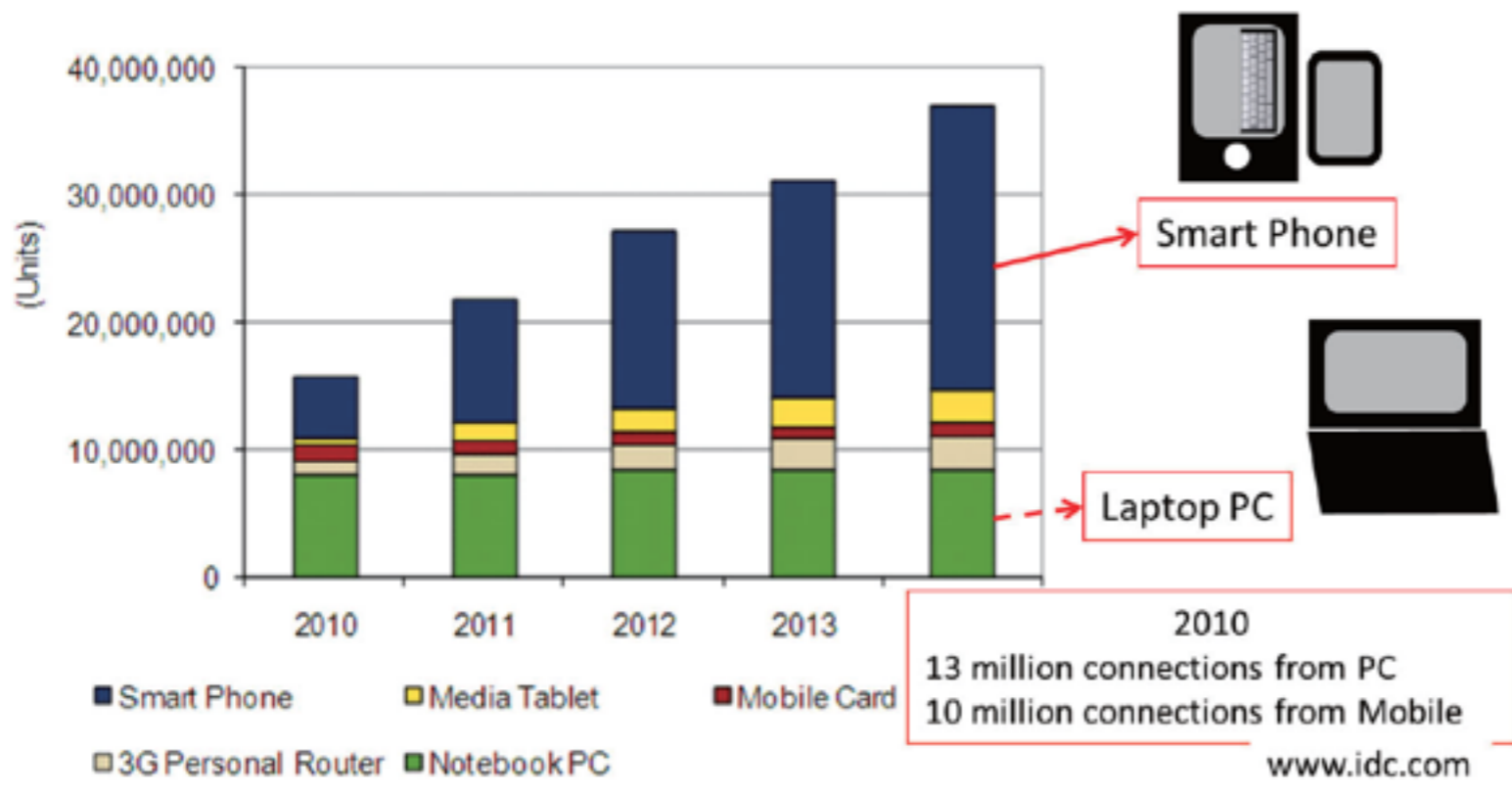
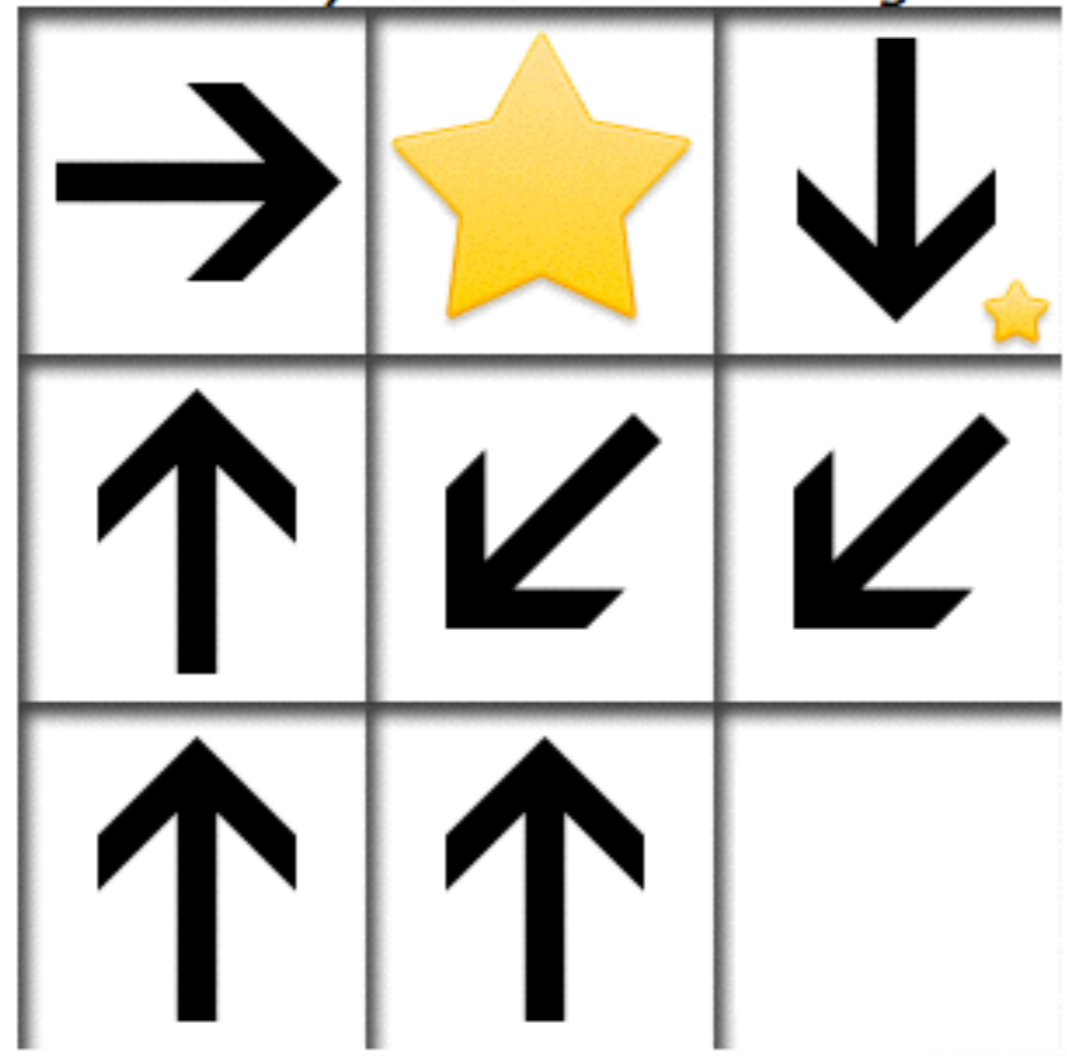

Fig. 5. New CAPTCHA Technique Using Noise Images

# Touch CAPTCHA

Click/Tap through the Maze:  
*Start at tiny star and end at big star*



Steps taken: 0/8 [Start Over](#)

[Test](#)



(a) Clickable captchas [36] (b) What's UP captcha [59]

Enter the correct characters.

GpBK



x	j	9	G
K	3	B	p

(c) Captcha zoo [81] (d) Lin's et al. captcha for mobile [81]



STAMP  
CAPTCHA

毒蛇猛兽

龙尾相击

天告

石未

范城杰阁

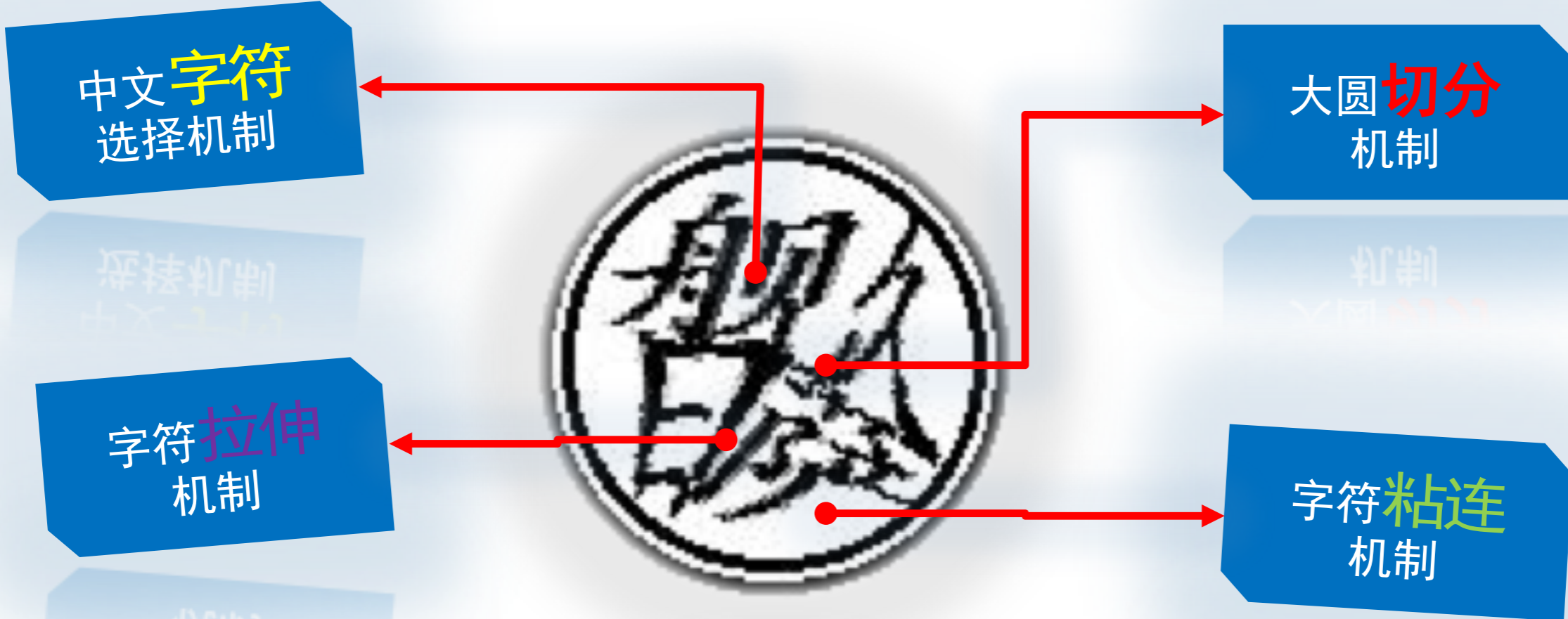

印章型 中文 CAPTCHA

# 主要机制

## 分割线

### 分割点

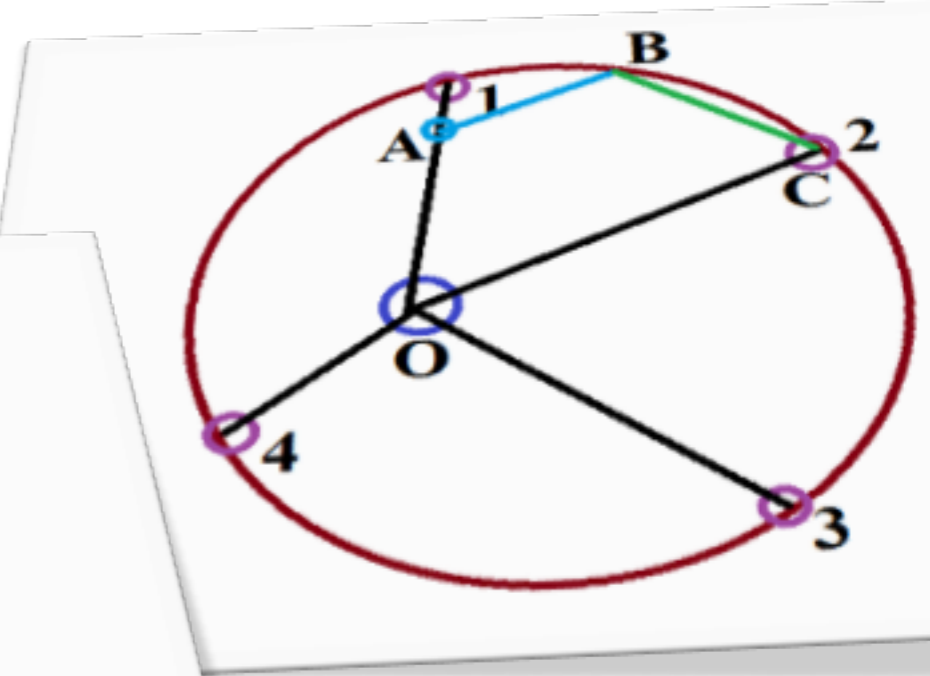
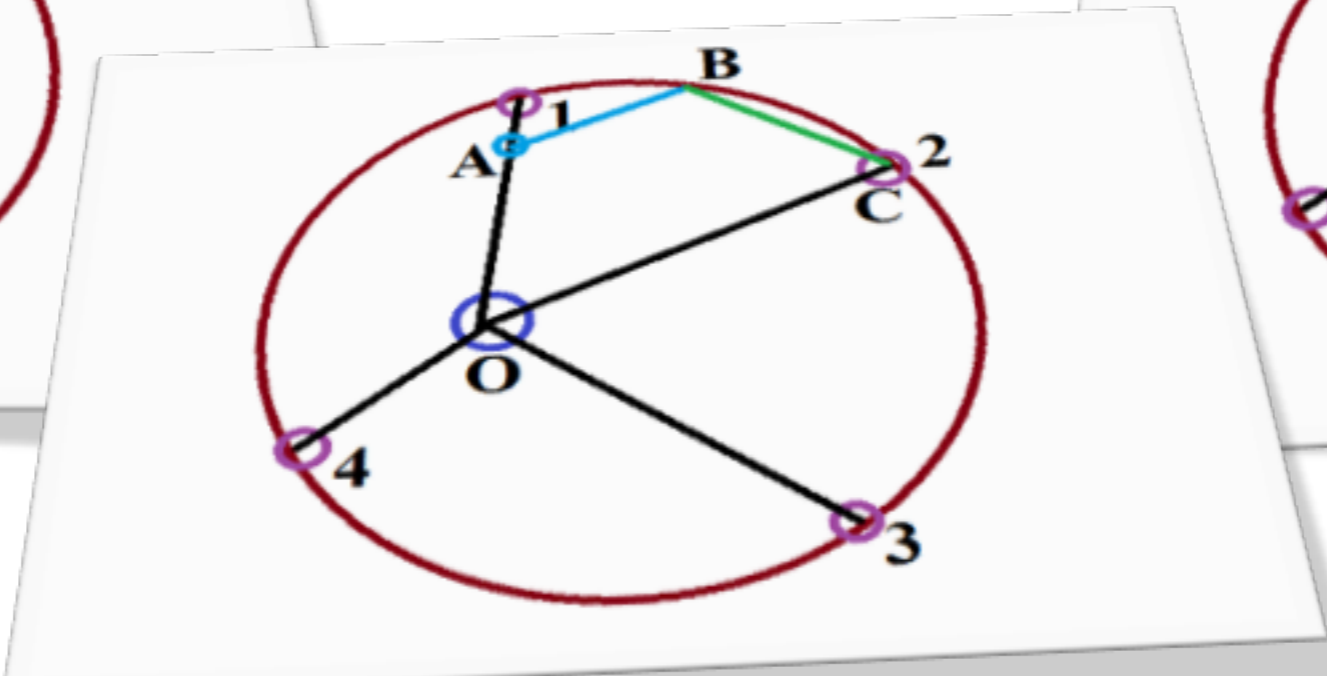
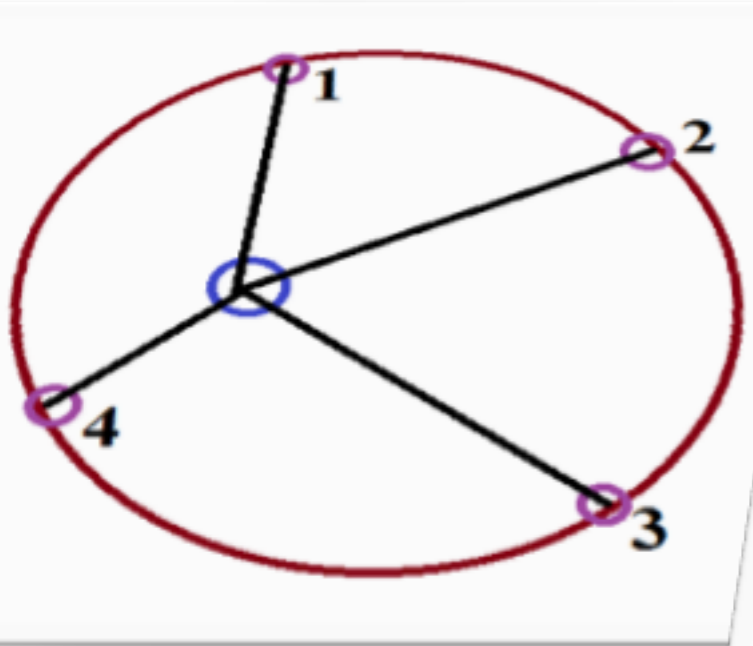
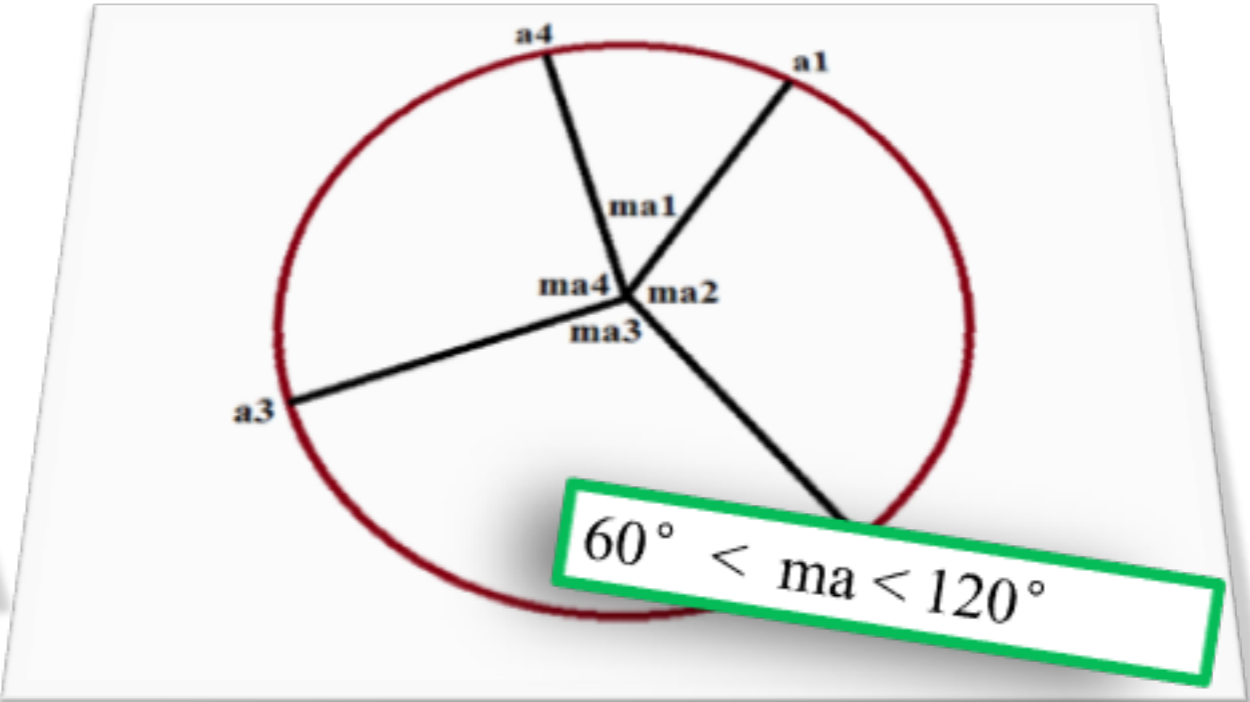
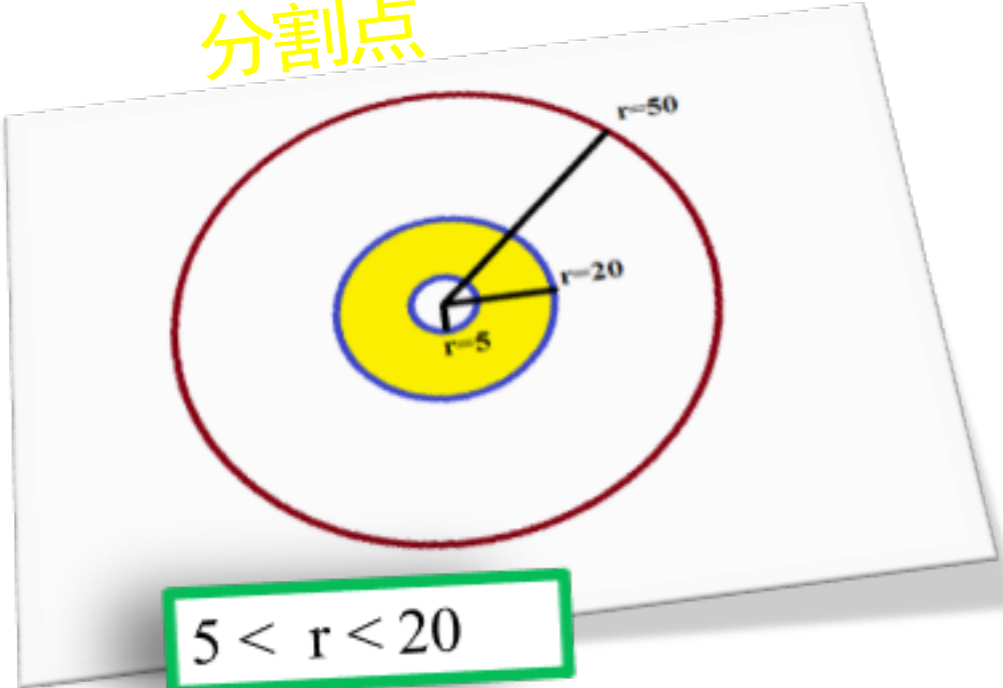

# 主要机制

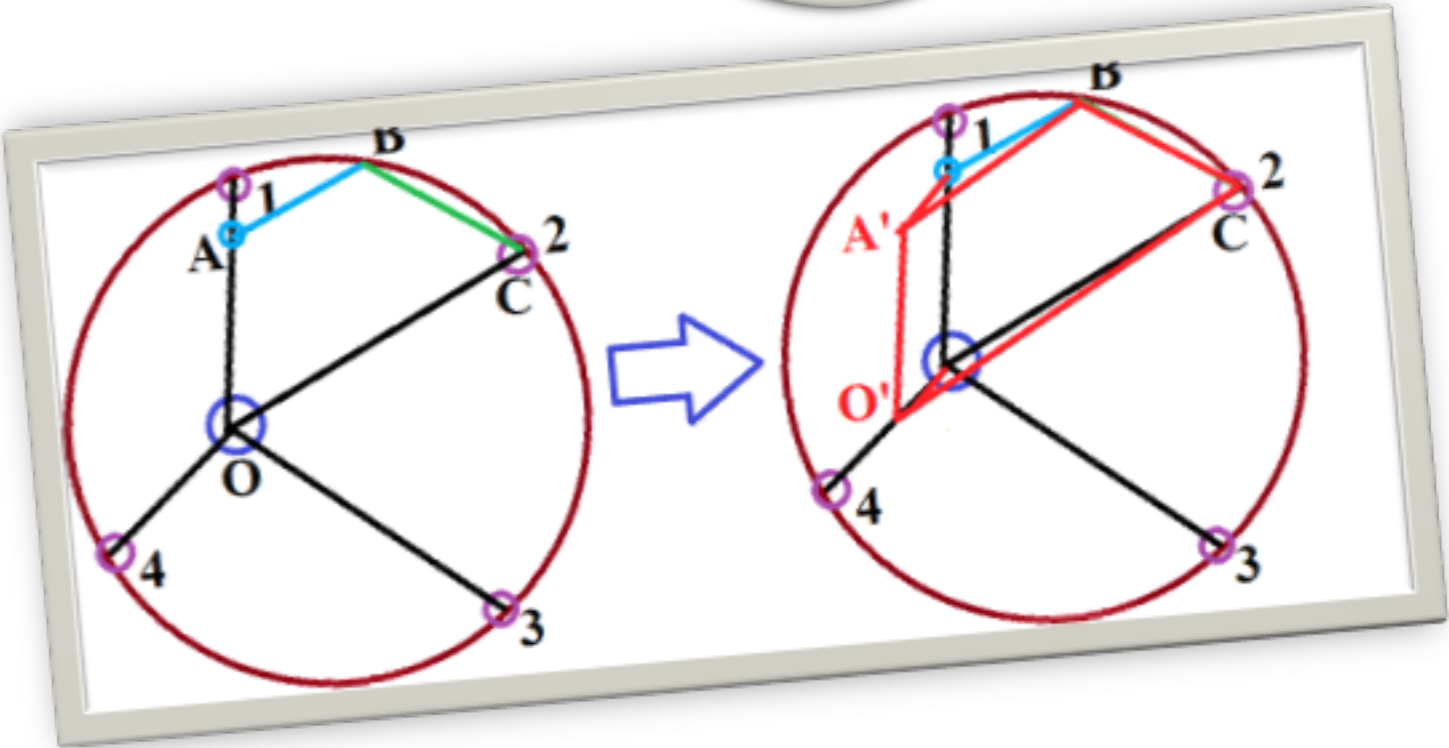
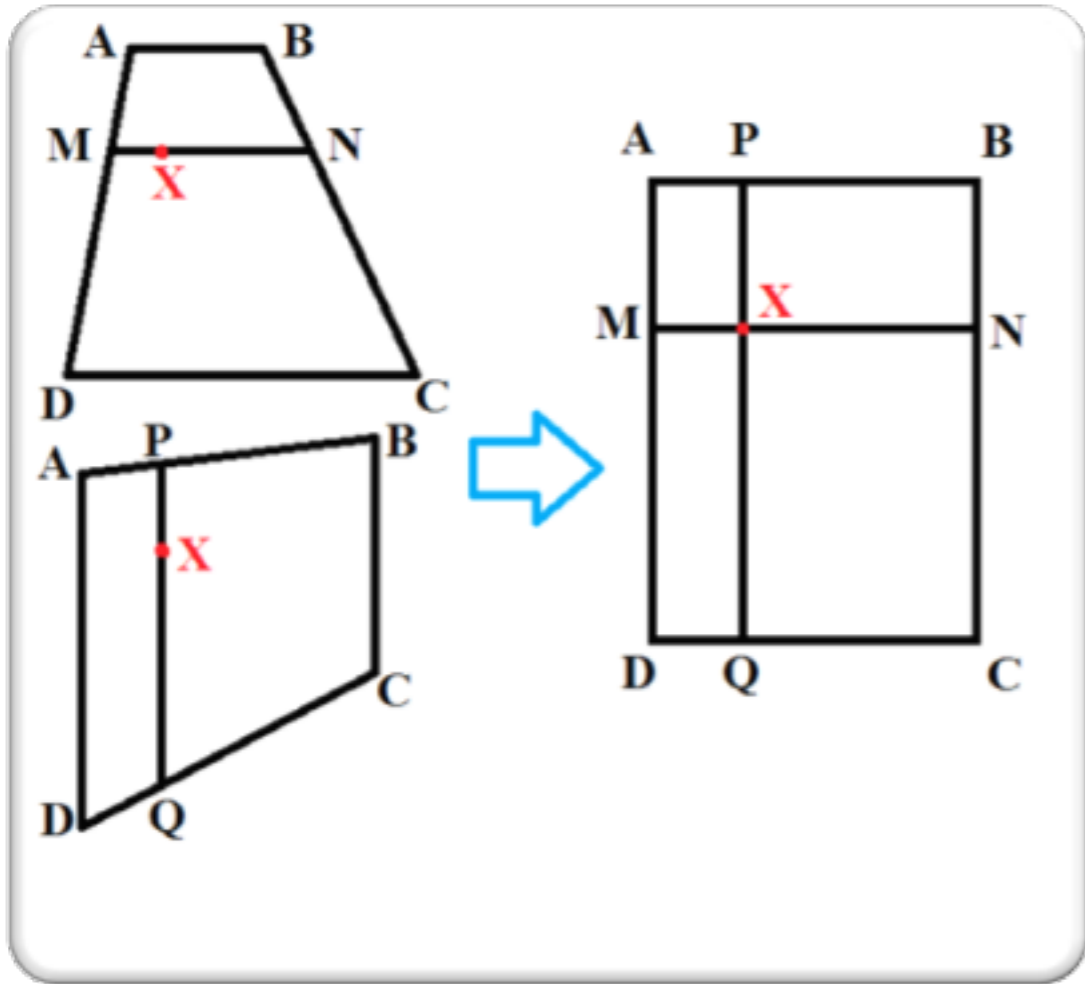

谢谢!

孙惠平

[sunhp@ss.pku.edu.cn](mailto:sunhp@ss.pku.edu.cn)